

Fitting for pivoting and lateral sliding in of wooden doors up to 35 kg (77 lbs.). Uniform, flush front design with even gap pattern. Push-to-open function for handle-less cabinet designs.

Product highlights

- Productivity** Easy installation thanks to high degree of pre-assembly with intuitive adjustment
- Comfort** Ergonomic movement support for even, smooth movement
- Aesthetics** Cabinet designs without handle – the technology remains invisible

Technical specifications

- 10–35 kg (22 to 77 lbs.)
- 1900–2700 mm (6' 2 13/16" to 8' 10 5/16")
- 440–750 mm (1' 5 5/16" to 2' 5 17/32")
- 18–26 mm (23/32" to 1 1/32")

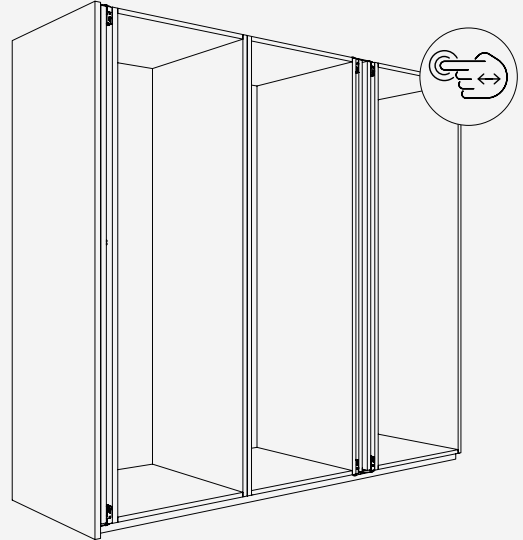

Installation examples

Door striking against the top and bottom cabinet sections

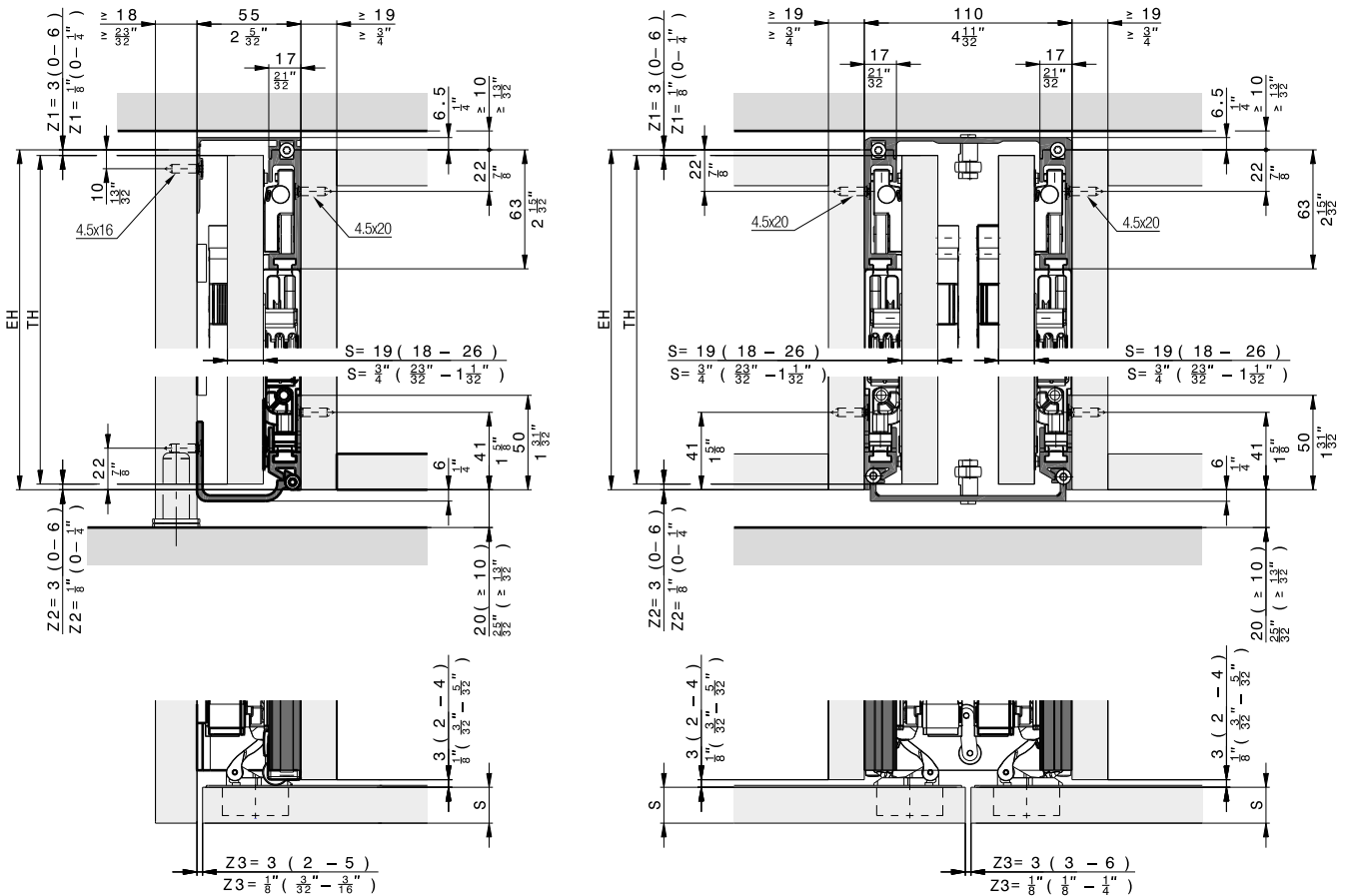

Components required for one cabinet

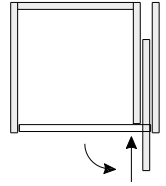
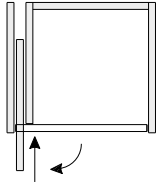

Hawa Concepta III 35 Push, left

	No.
Hawa Concepta III 35, basic set left, door height 1900–2700 mm (6' 2 13/16" to 8' 10 5/16")	30996
Hawa Concepta III 25/35, Push slide-in set, left	30998
Upright profile L= 2474 mm (8' 1 13/32"), for door height 1900–2700 mm (6' 2 13/16" to 8' 10 5/16"), aluminum, anodized	30771

Hawa Concepta III 35 Push, right

	No.
Hawa Concepta III 35, basic set right, door height 1900–2700 mm (6' 2 13/16" to 8' 10 5/16")	30997
Hawa Concepta III 25/35, Push slide-in set, right	30999
Upright profile L= 2474 mm (8' 1 13/32"), for door height 1900–2700 mm (6' 2 13/16" to 8' 10 5/16"), aluminum, anodized	30771

Weight and door size ratio calculations

The maximum weight must be adapted depending on the door size ratio.

DE Türbreite / FR Largeur de porte / EN Door width / IT Larghezza anta / ES Ancho de puerta

DE Türhöhe / FR Hauteur de porte / EN Door height / IT Altezza anta / ES Altura de puerta	DE Türbreite / FR Largeur de porte / EN Door width / IT Larghezza anta / ES Ancho de puerta						
	440	500	550	600	650	700	750
2700	35	35	35	35	35	35	35
2650	35	35	35	35	35	35	35
2600	35	35	35	35	35	35	35
2550	35	35	35	35	35	35	35
2500	35	35	35	35	35	35	35
2450	35	35	35	35	35	35	34
2400	35	35	35	35	35	35	33
2350	35	35	35	35	35	34	32
2300	35	35	35	35	35	34	31
2250	35	35	35	35	35	33	31
2200	35	35	35	35	34	32	30
2150	35	35	35	35	33	31	29
2100	35	35	35	35	32	30	28
2050	35	35	35	34	31	29	27
2000	35	35	35	33	30	28	26
1950	35	35	35	32	29	27	26
1900	35	35	34	31	29	27	25

DE Türgewicht in kg / FR Poids de porte en kg / EN Door weight in kg / IT Peso anta in kg / ES Peso de puerta en kg

	DE Türbreite / FR Largeur de porte / EN Door width / IT Larghezza anta / ES Ancho de puerta									
	1' 5 5/16"	1' 7 11/16"	1' 9 21/32"	1' 11 5/8"	2' 1 19/32"	2' 3 9/16"	2' 5 17/32"			
8' 10 5/16"	77	77	77	77	77	77	77			
8' 8 11/32"	77	77	77	77	77	77	77			
8' 6 3/8"	77	77	77	77	77	77	77			
8' 4 13/32"	77	77	77	77	77	77	77			
8' 2 7/16"	77	77	77	77	77	77	77			
8' 0 15/32"	77	77	77	77	77	77	75			
7' 10 1/2"	77	77	77	77	77	77	73			
7' 8 17/32"	77	77	77	77	77	75	71			
7' 6 9/16"	77	77	77	77	77	75	68			
7' 4 19/32"	77	77	77	77	77	73	68			
7' 2 5/8"	77	77	77	77	75	71	66			
7' 0 21/32"	77	77	77	77	73	68	64			
6' 10 11/16"	77	77	77	77	71	66	62			
6' 8 23/32"	77	77	77	75	68	64	60			
6' 6 3/4"	77	77	77	73	66	62	57			
6' 4 25/32"	77	77	77	71	64	60	57			
6' 2 13/16"	77	77	75	68	64	60	55			

DE Türgewicht in lbs. / FR Poids de porte en lbs. / EN Door weight in lbs. / IT Peso anta in lbs. / ES Peso de puerta en lbs.

DE Maximale Gewichte in kg / FR Poids maximale en kg / EN Maximum weights in kg / IT Pesi massimo in kg / ES Pesos máximos en kg













DE Maximale Gewichte in lbs. / FR Poids maximale en lbs. / EN Maximum weights in lbs. / IT Pesi massimo in lbs. / ES Pesos máximos en lbs.

Hawa Configurator

List of individual parts, which are included in the sets:







Set for 1 pivot /slide-in door up to 35 kg (77 lbs.)

	No.
Hawa Concepta III 35, basic set left, door height 1900–2700 mm (6' 2 13/16" to 8' 10 5/16")	30996
Hawa Concepta III 35, basic set right, door height 1900–2700 mm (6' 2 13/16" to 8' 10 5/16")	30997

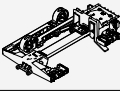

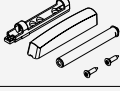
	30996	30997	No.
<b>Set consisting of:</b>			
 Slot nuts for hinge attachment, plastic, black	4	4	30686
 Mounting plate for hinge with height adjustment, steel, nickel-plated	1	1	30738
 Concealed hinge, with soft closing mechanism and closing spring, steel, nickel plated	4	4	31070
 Set for concealed hinges, 8 screws 4x16 mm (5/32"x5/8"), 3 door stop buffers	1	1	30811
 Profile for magnetic guide, with double-sided adhesive tape, steel, black, L=730 mm (2' 4 3/4")	2	2	30983
 Euro screw, 6x13 mm (1/4"x1/2"), steel, black, set of 6 pieces	1	1	30986
 Bottom guide track left, aluminum, anodized, L= 838 mm (2' 9")	1		30805
 Top running track left, aluminum, anodized, L= 838 mm (2' 9")	1		31059
 Countersunk head screw, 4.5x20 mm (5/32"x25/32"), steel, zinc-plated, set of 16 pieces	1	1	30810
 Set of adjusting tools	1	1	31047
 Bottom guide track right, aluminum, anodized, L= 838 mm (2' 9")		1	30806
 Top running track right, aluminum, anodized, L= 838 mm (2' 9")		1	31060

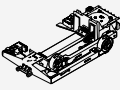
Suitable slide-in set

	No.
Hawa Concepta III 25/35, Push slide-in set, left	30998
Hawa Concepta III 25/35, Push slide-in set, right	30999

	30998	30999	No.
<b>Set consisting of:</b>			
 Hawa Concepta III 25/35 Push slide-in unit, left	1		31038
 End stop bracket for push ejector, steel, zinc-plated	1	1	31043
 Push ejector, plastic, black	1	1	31010
 Push-to-open with adapter plate, plastic, black	1	1	30838
 Hawa Concepta III Push set of cover caps, for left-hand stop, plastic, black	1		30818
 Hawa Concepta III 25/35 Push slide-in unit, right		1	31039
 Hawa Concepta III Push set of cover caps, for right-hand stop, plastic, black		1	30827

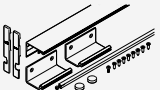
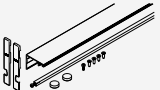
**Cabinet connecting parts**

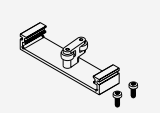
		mm (inch)	No.
	Connector set 55 mm (2 5/32"), for exterior connection to cabinet	560 (1' 10 1/16")	31005
	Connector top 55 mm (2 5/32"), for exterior connection to cabinet	560 (1' 10 1/16")	31430
	Connector top 110 mm (4 11/32"), for two pivot/slide-in doors	500 (1' 7 11/16")	31006
	Connector bottom 110 mm (4 11/32"), for two pivot/slide-in doors	500 (1' 7 11/16")	31246
	Connector bottom 110 mm (4 11/32"), for two pivot/slide-in doors (for installation in front of fixed plinth)	26 (1 1/32")	31007

**Guides**

		No.
	Guide for two inset pivot sliding doors, aluminum	25680

**Accessories**

		No.
	Support for Halemeier automatic shut-off device Matching push button item 36 979 01 for Halemeier automatic shut-off device (Safety Box)	31020

**Straightening fitting, aluminum**

→ Details from page 266

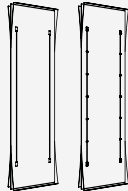
		No.
	Straightening fitting for doors 2240–2850 mm (7' 4 3/16" to 9' 4 7/32"), aluminum, anodized, can be shortened for doors 1215–2240 mm (3'11 27/32" to 7'4 3/16")	056.3192.071
	Straightening fitting for doors 2040–2600 mm (6' 8 5/16" to 8' 6 3/8"), aluminum, can be shortened for doors 1775–2040 mm (5'9 7/8" to 6'8 5/16")	056.3192.072

**Straightening fitting, aluminum, black anodized**

→ Details from page 266

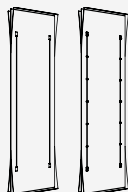
		No.
	Straightening fitting for doors 2240–2850 mm (7' 4 3/16" to 9' 4 7/32"), aluminum, anodized, black	056.3192.074
	Straightening fitting for doors 2040–2600 mm (6' 8 5/16" to 8' 6 3/8"), aluminum, black anodized, can be shortened for doors 1775–2040 mm (5'9 7/8" to 6'8 5/16")	056.3192.075

**Straightening fitting**

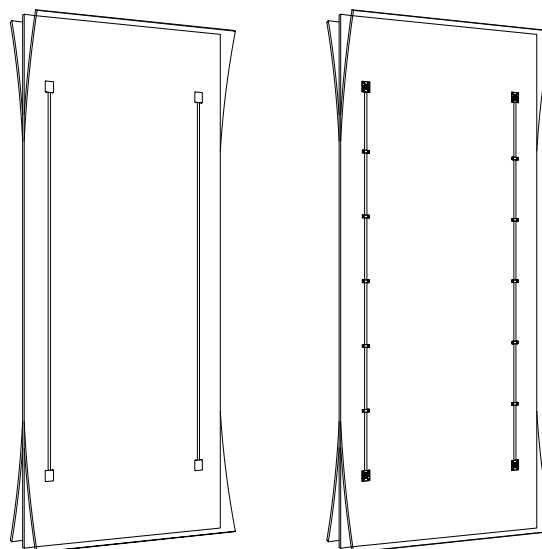

Further installation examples  
Composed cabinet

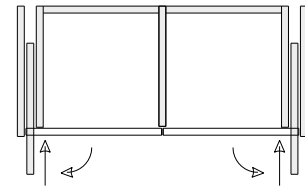
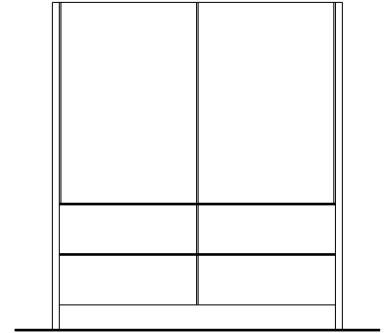
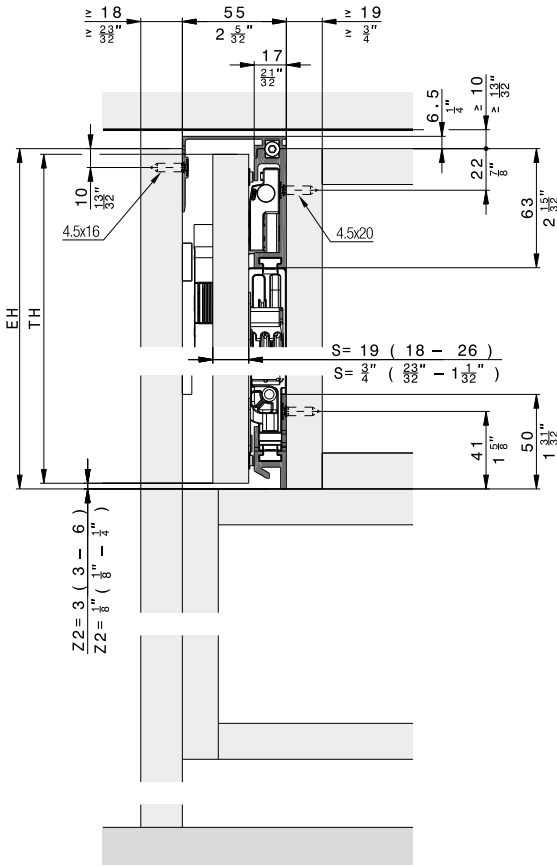

Cabinet without base panel

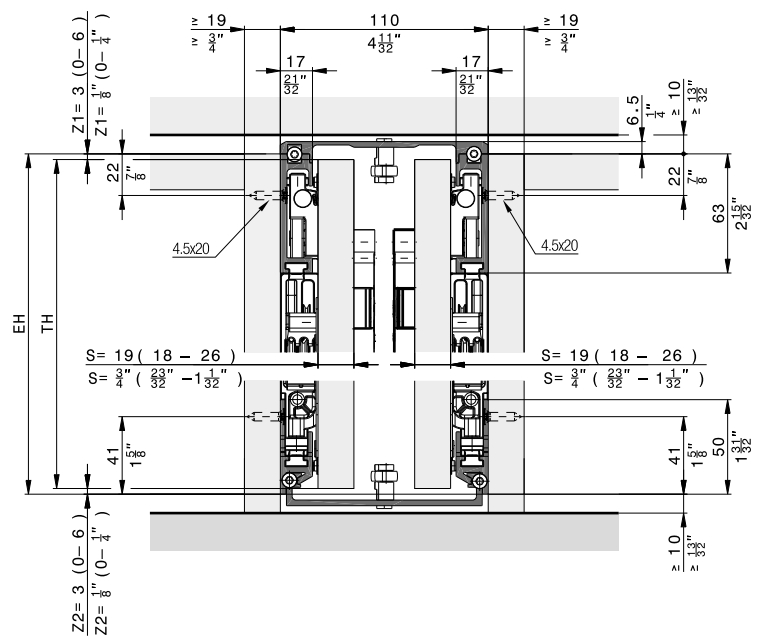
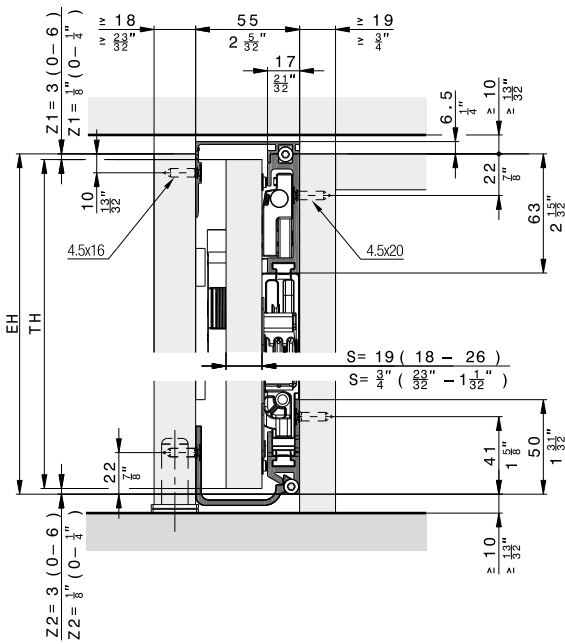

Inlaid doors

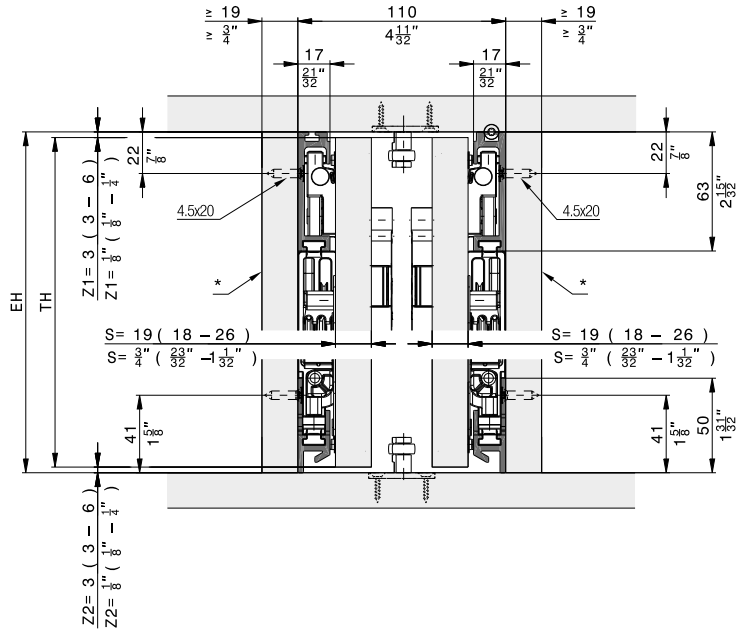
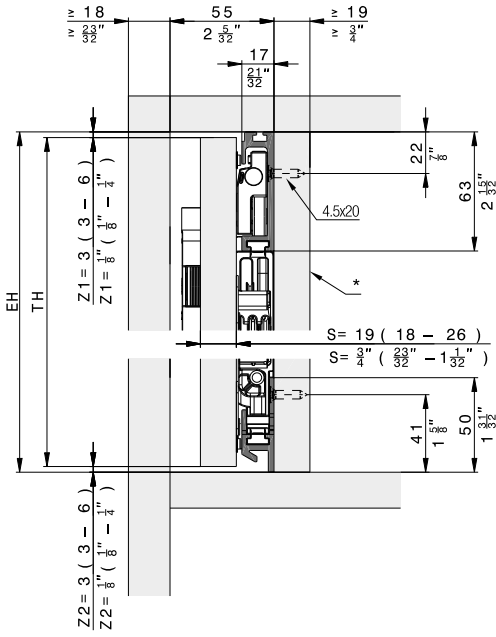

\* emovable

Floor-to-ceiling doors

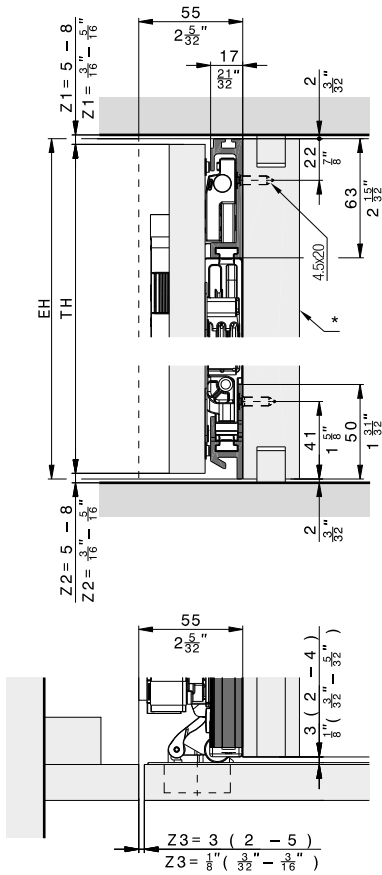

\* emovable

Hardware depth calculation

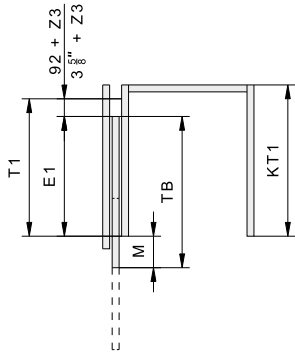

	mm	Inch
T1	≥ 414	≥ 1' 4 <sup>5</sup> / <sub>16</sub> "

	mm	Inch
T1	TB + 92 + Z3 - M	TB + 3 <sup>5</sup> / <sub>8</sub> " + Z3 - M
E1	TB - M	TB - M
M	≥ S + 3 ≤ TB - 320	≥ S + <sup>5</sup> / <sub>8</sub> " ≤ TB - 1 <sup>19</sup> / <sub>32</sub> "

Door flush with outer face

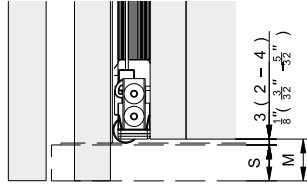

Protruding door

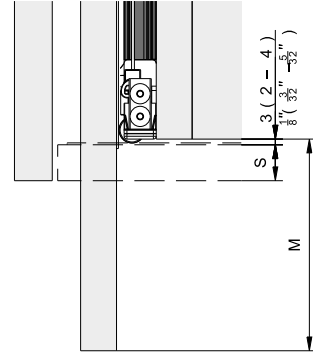

Instructions

Videos

Accessories

– Straightening fitting from page 266

Planning/execution

Configure with just a few clicks at [www.hawa.com/configurator](http://www.hawa.com/configurator)

Further information about the product can be found on [www.hawa.com](http://www.hawa.com).